

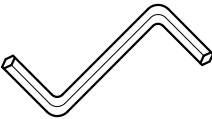

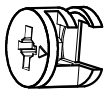

 Ø6,4x50 mm A1 x 16	 Ø12 mm A2 x 16	 4 mm A3 x 1	 Ø15x12 mm B1 x 4	 Ø5x44 mm B2 x 4
 Ø20 mm B3 x 4	 Ø4x16 mm D1 x 16	 Ø1,6x25 mm F x 26	 Ø8x36 mm G x 22	 M x 4
 Ø15 mm N x 4				

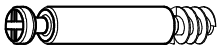

Box 1

698x388x3 mm

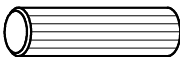
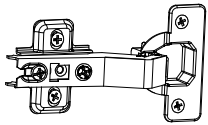

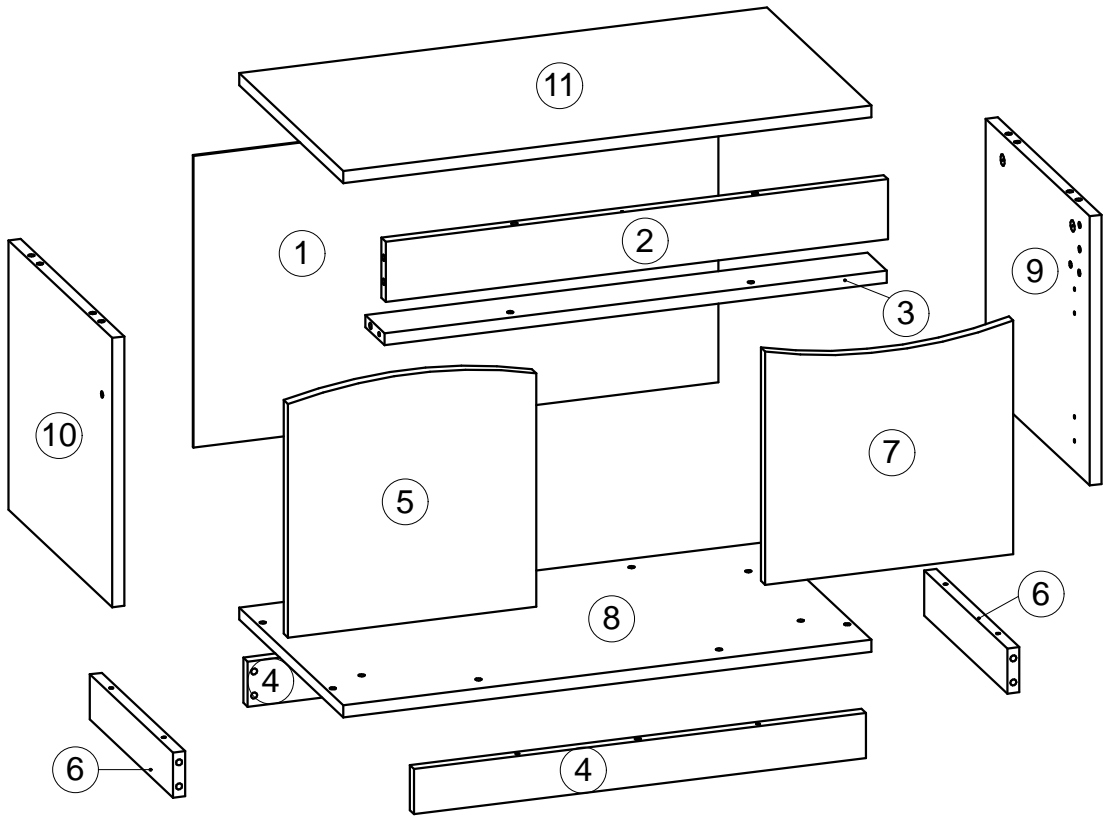
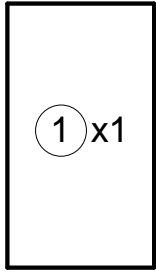
80x668x16 mm

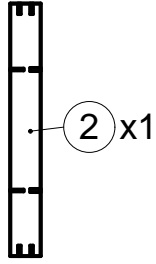

668x70x16mm

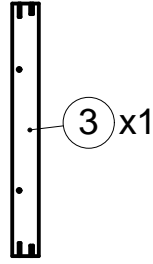

60x600x16 mm

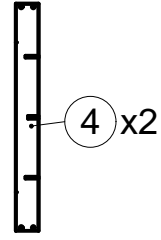

329x330x16 mm

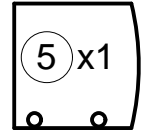

60x304x16 mm

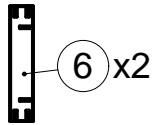

329x310x16 mm

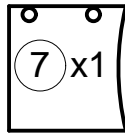

701x380x16mm

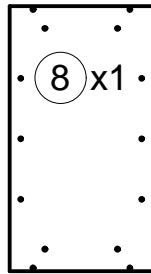

358x379x16 mm

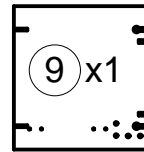

358x379x16 mm

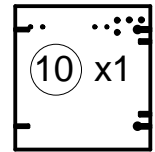

701x380x16 mm

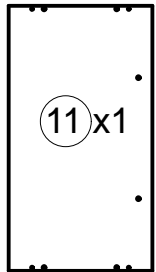

Fittings & Tools

1

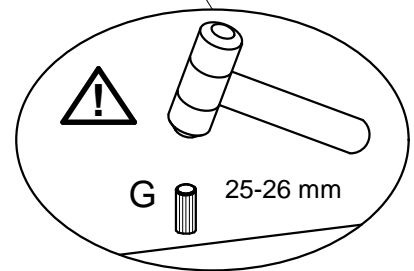
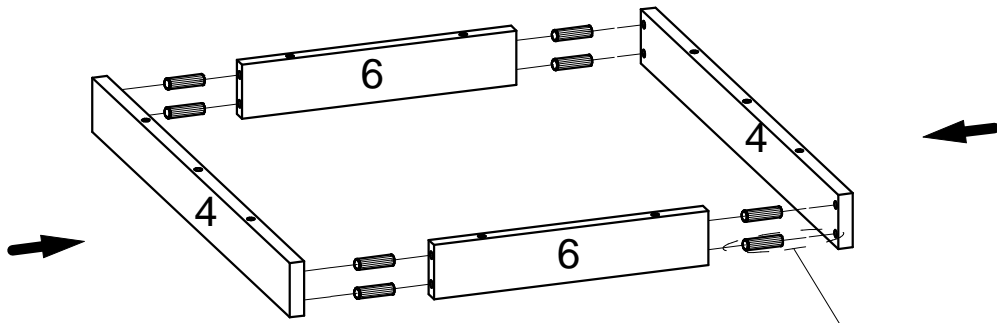
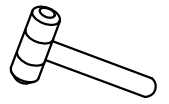
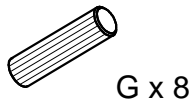

2

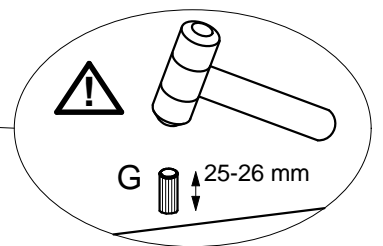
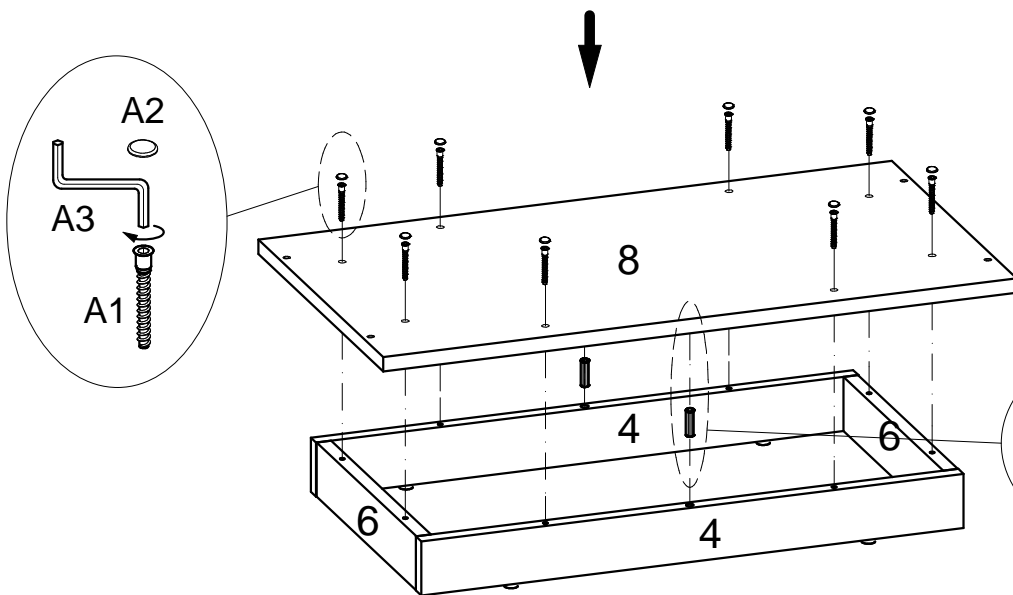
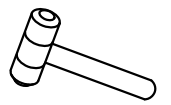
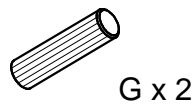
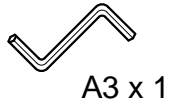
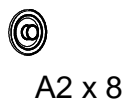
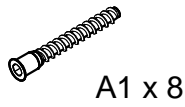

3

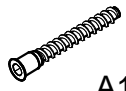

A1 x 2



A2 x 2



A3 x 1

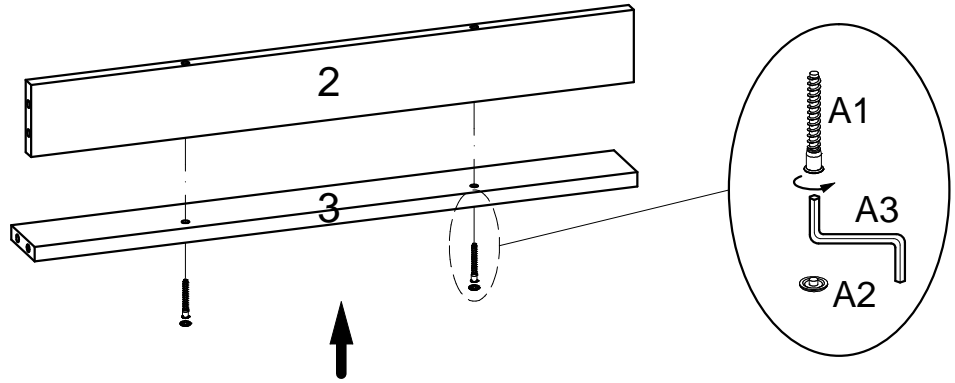

4

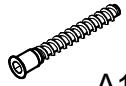

A1 x 2



A2 x 2



A3 x 1

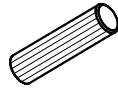

G x 6

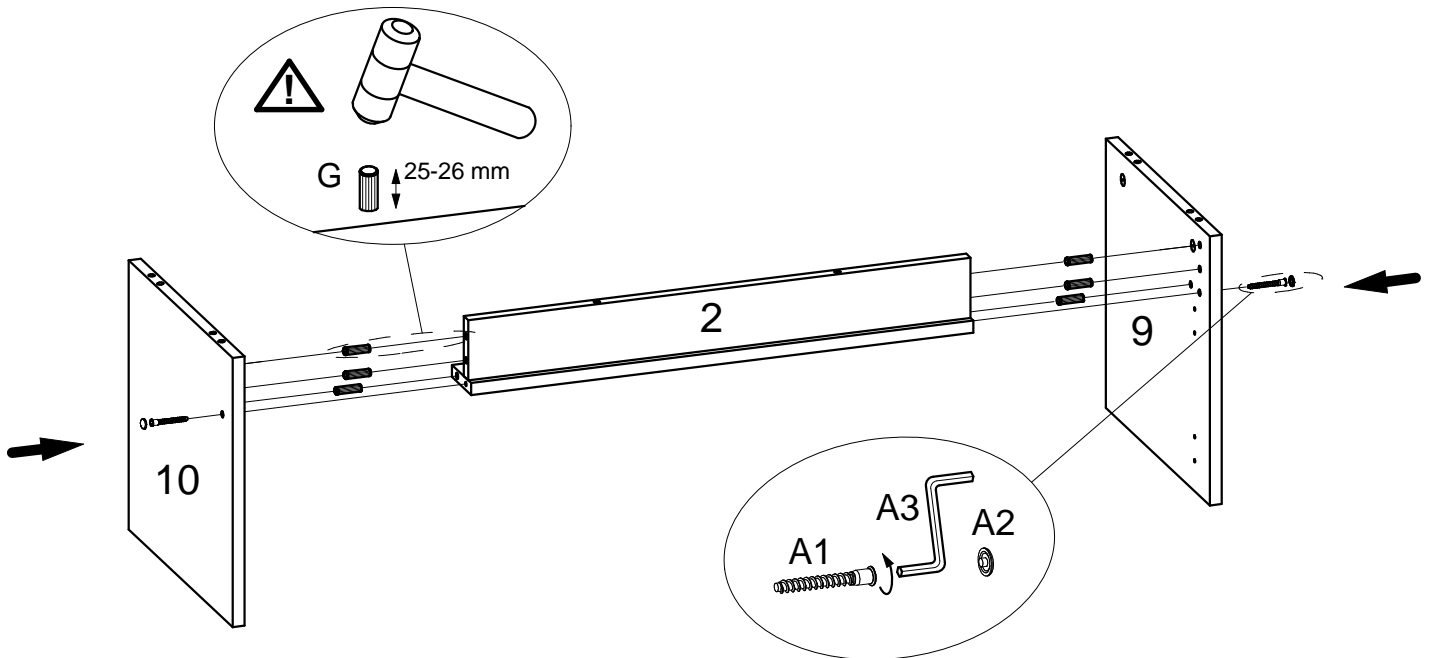
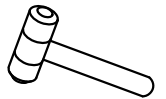

5

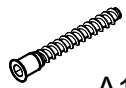

A1 x 4



A2 x 4

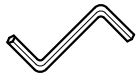

A3 x 1

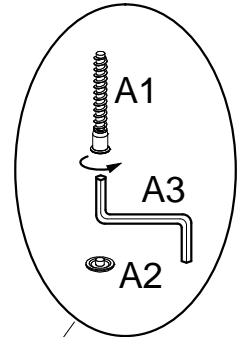
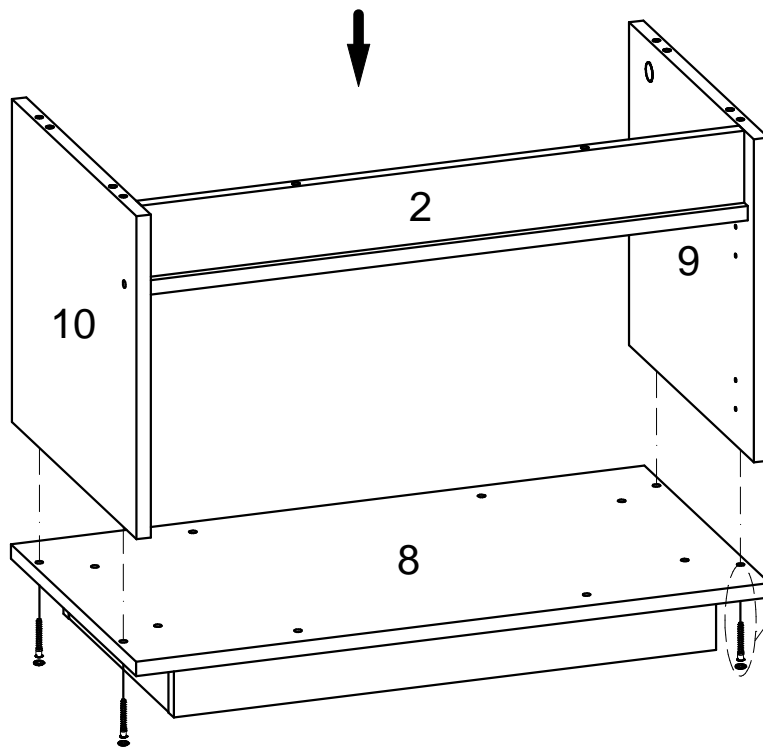

6



B1 x 4

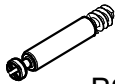

B2 x 4



B3 x 4

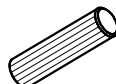

G x 6

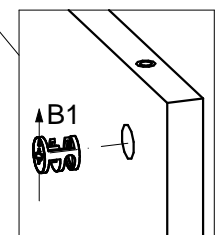
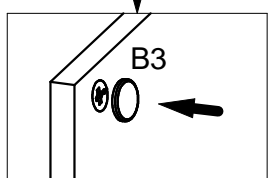
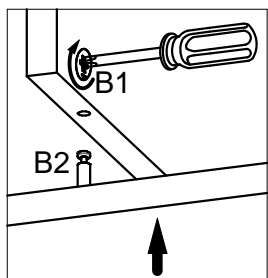
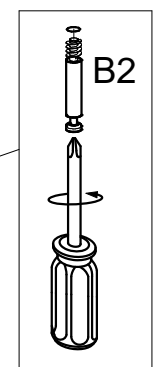
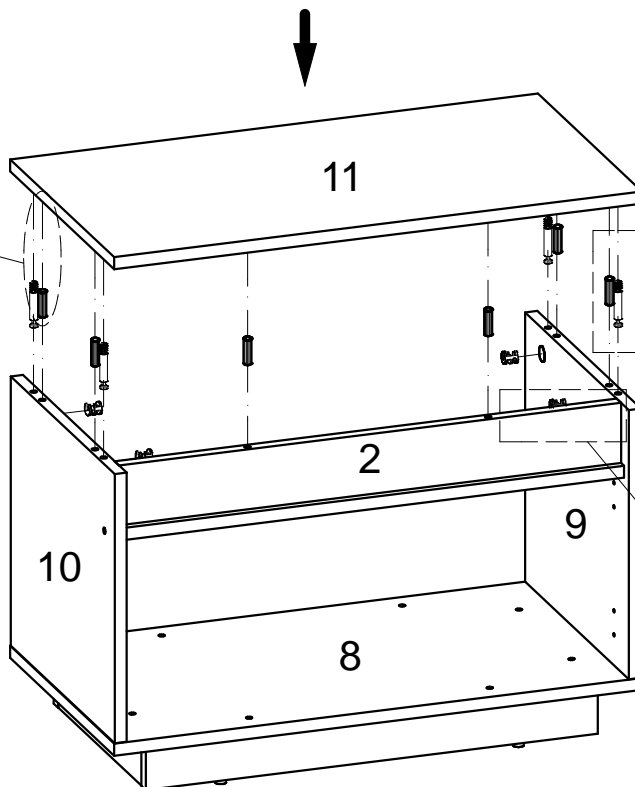
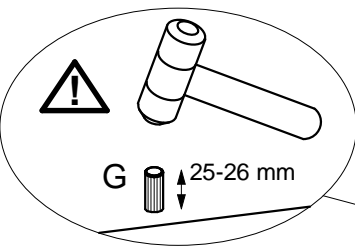
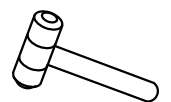
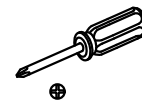

7

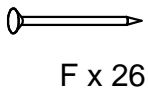

F x 26



N x 4

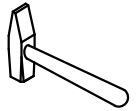

$XX=YY \cong 90^\circ$

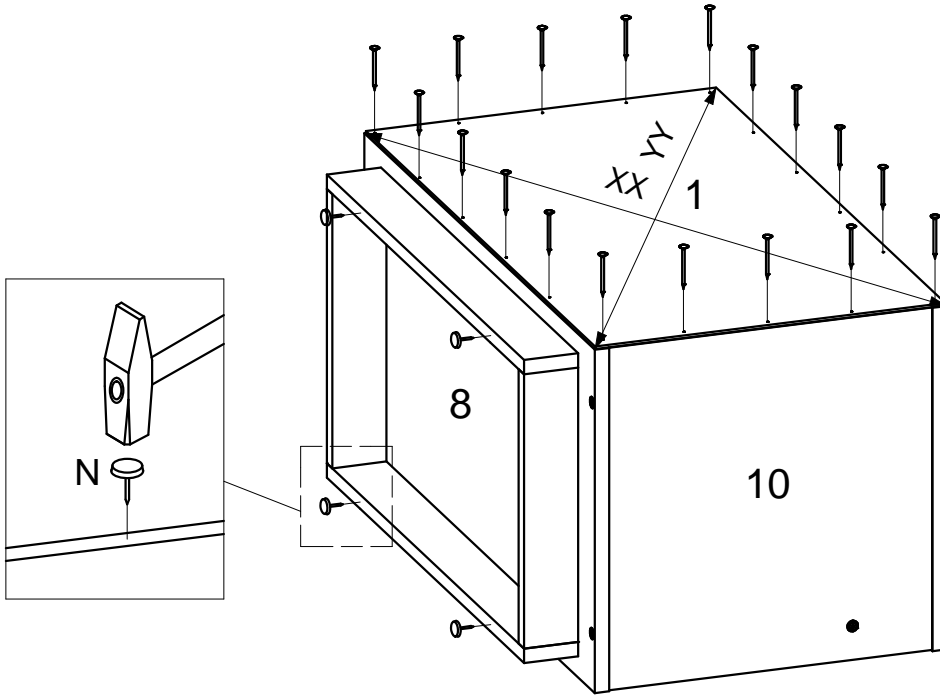

8



D1 x 16

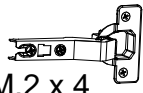

M.2 x 4



M.1 x 4

